

50<sup>+</sup>  
years

SHADING  
EXPERT  
2023

tevälli®  
parasol's

50<sup>+</sup>  
years



## Fifty years of experience in parasols and shade systems...

*There are those invaluable things... You can only understand their values when you do not have them... just like a parasol. Nobody remembers a wing to hide under before one gets soaking wet in the rain or a shade to take shelter against roasting sun. Right at the beginning of a long talk, the parasol we sit under disappears from our minds. We do not notice that we have a better taste of a wonderful food under a shade the best.*

*And there are those things... They help increase the comfort of our lives. Then, they become inevitable after they are noticed.*

*Thus, with the aim of adding comfort to life, we commenced a journey for parasols in 1971 under the name Türk Şemsiye Sanayii (Turkish Parasol Industry). Following an experience of 20 years, in 1990, we began to protect you against sunlight by our beach parasols. When the world was celebrating the millennium in 2000, we worked hard to enlarge our shades thanks to our Mega Parasols. In 2020, we started providing professional solutions to the Horeca market by our crank and telescopic products. Moreover, for areas where classical solutions are not sufficient, we started developing pergola systems. Additionally, we attached lights to these shades through solar system integrations. Thanks to this, we were able to adapt technology for parasol systems. We are still growing and developing by prioritizing our innovative stance.*

*In our journey started in 1959 by our forerunners and founders of Tevalli, our shade is growing every year.*

*We wish you sunny days when you can enjoy the breeze under Tevalli Parasols.*

**tevalli**  
parasol's

PRODUCT RANGE

---



ATLANTIC

6



RODOS

36

COSMOS

18



TROPIC

42



ALBATROS

28



PULLEY

48



# Usage Areas



## Hotels / Restaurants

These are durable products for hotels and restaurants, and they present customization features specific to location and brand identity. Not only do they reflect the characteristics of businesses, they also make it possible for your guests to enjoy their comfortable times at outdoor living areas.



## Gardens / Terraces

They present a comfortable outdoor experience in the gardens, terraces, or social areas of residences.



## Poolsides

They provide you with enjoyable shading area around the pools as perfect companions to sunbeds and sitting sets.



## Balconies

They offer a protective and comfortable living areas at your balconies.



## Beaches

They accompany your joyful moments on the beaches as perfect companions to sunbeds.

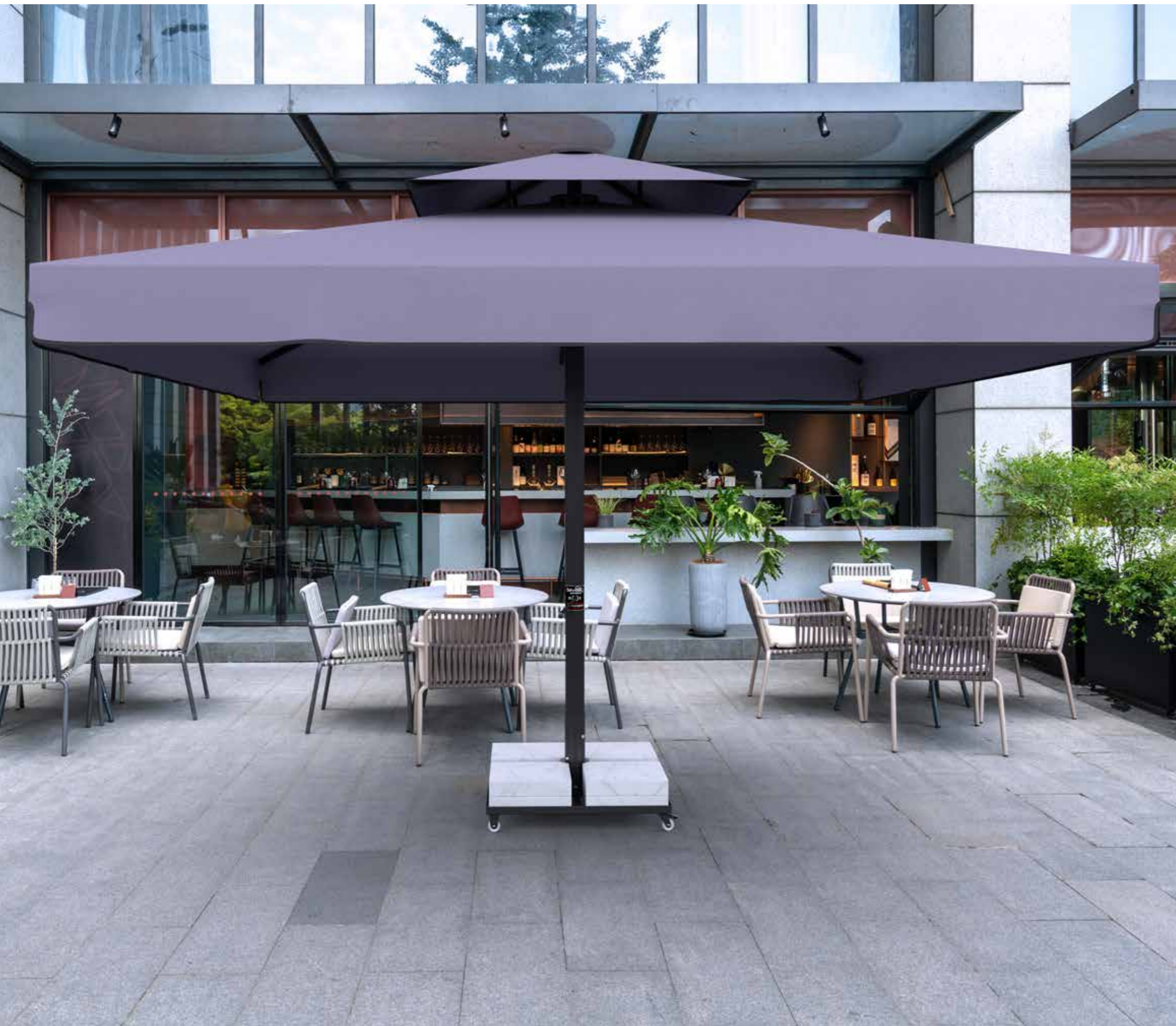

## ATLANTIC

### PRODUCT

The Atlantic Parasol that offers the maximum protection area on single pole has a casting hardened aluminium frame. The moving telescopic system with crankshaft that is made of steel gives a seamless opening and closing experience. The water repellent fabric provides comfort under light rain and high-quality acrylic fabrics were used in the production against colour degrading. Thanks to the shaders, they offer great performance for protecting you against UV rays. Through the structure that resist harsh weather conditions and wind, they give you a long-term use.

The Atlantic Parasol furnishes your guests with a unified comfort area via your corporate identity thanks to its logo customization features for organizations like restaurants and hotels, frame and fabric customization features, complementary accessories, and technology packets.

## TECHNOLOGY

By converting sunlight into energy via its solar panel, the Atlantic Parasol stores power in its integrated battery.

The remote control enables the controlling of the electric motor of the telescopic mechanism as well as the led lighting. To create a comfortable living area under the parasol in cold weather conditions, an energy infrastructure that can provide external power to the heaters use can be fitted.

All the energy related parts used on the parasol were made in Türkiye.

As far as the lighting is concerned, Osram 3000 Kelvin LEDs were used.





### **For Hotels and Restaurants**

They offer maximum protection for outdoor living areas of hotels and restaurants. The durable and long-lasting structure help you and your guests have joyful moments under both sunny hot days and light rain conditions.

### **For Brands and Shops**

It furnishes your guests with a unified comfort area via your corporate identity thanks to its logo customization features for organizations like restaurants and hotels, frame and fabric customization features, complementary accessories, and technology packets.

### **For Gardens and Outdoor Areas**

On single pole, it offers maximum shading and a comfortable living area at your gardens and terraces. It provides you with an ideal comfort area so that you can enjoy nice weather outside.

### **Suitable for Profesional Users**

It helps professional users and designers developing projects add comfort and joy to the locations they work on.



Electronic control unit with remotes



3000 Kelvin Led



Auxiliary charging unit

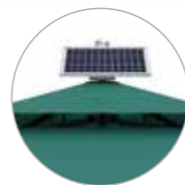

Solar panel

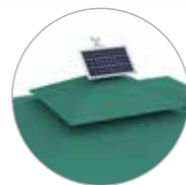

Funnel for wind resistance

## TECH PACKAGES

- Solar Panel + Led Lights
- Solar Panel + Remote Control Motor + Led Lights + Wind Sensor
- External Power + Led Lights
- External Power + Heater Supply Sockets infrastructure

## FRAME

**Aluminum:** EN-AW/6005 NORM - 85/90 HB HARDENED

**Connective Parts:** ETI-AL 71 CAST ALUMINUM

**Mast Profile:** Ø100 mm and 3,5 mm wall thickness

**Telescop profile:** Ø71 mm and 3,5 mm wall thickness

**Arms:** 20x40 mm and 2 mm wall thickness

## FRAME - MINI

**Aluminum:** EN-AW/6005 NORM - 85/90 HB HARDENED

**Connective Parts:** ETI-AL 71 CAST ALUMINUM

**Mast Profile:** Ø82 mm and 3 mm wall thickness

**Telescop profile:** Ø55 mm and 3 mm wall thickness

**Arms:** 20x30 mm and 2 mm wall thickness



Crank shaft mechanism

## Frame Coloring

Natural anodised aluminum color

**Optional:** Powder-Coated Ral color selections

## DRIVE SYSTEM

Thanks to the durable ck-45 steel helical gear structure, the Atlantic series with Counter-Rotating Telescopic System has a long-life span.

## HOW TO OPERATE

With its detachable crank, the parasol can be opened and closed with minimum effort. The optional electric motor enables movement with a click of a button on the remote control.





## FIXATIONS



Weight: 270 - 200 kg  
Wheeled Stand With Marble



High Resistance For Wind  
Floor Mounting Plate



High Resistance For Wind  
Tip-over Floor Mounting Plate



High Resistance For Wind  
Concentrate Bedding Plate

## ADDITIONAL OPTIONS



- Decorative Ireko Wooden Cover for wheeled stand



- Decorative Compact Cover for wheeled stand



- Logo printing (flounce and roof)



- Flounce



- Frame painting with all Ral color selections

- Rain Gutters Between Parasol

## Product Sizes

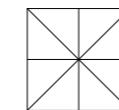
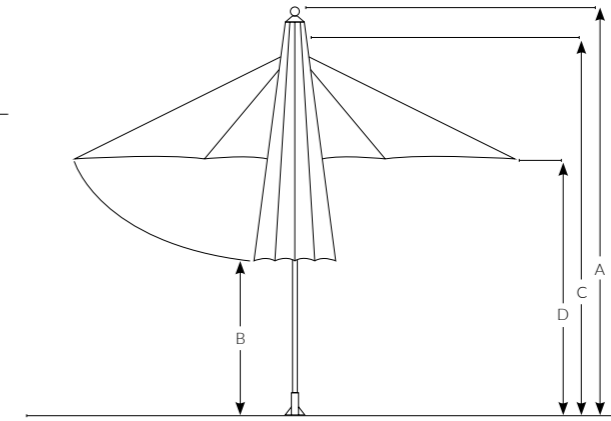

Nominal size	Covered area	Closed height		Open height	Headroom	Product Weight	Wind Resistance
		cm		cm	cm		
cm	m <sup>2</sup>	A	B	C	D	kg	1/10
300x300 mini	9	386	163	295	205	31,5	10/10
350x350 mini	12,25	395	135	304	205	34	9/10
400x400	16	416	122	306	215	46	10/10
450x450	20,25	423	135	317	215	50,5	9/10
500x500	25	520	145	364	225	64	9/10
550x550	30,25	530	120	370	225	72	8/10
600x600	36	536	100	376	235	82,5	7/10

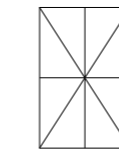

300x400	12	384	125	295	205	41,75	8/10
350x450	15,75	416	135	310	215	45,5	8/10
400x500	20	512	145	355	225	55	8/10
450x550	24,75	514	120	355	225	61,25	7/10
500x600	30	515	110	360	235	73,25	7/10

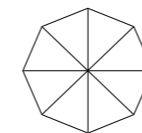

300 Ø mini	6,4	386	163	295	205	28,98	10/10
350 Ø mini	8,7	395	135	304	205	31,28	9/10
400 Ø	11,3	416	122	306	215	42,32	10/10
450 Ø	14,3	423	135	317	215	46,46	9/10
500 Ø	17,7	520	145	364	225	58,88	9/10
550 Ø	21,4	530	120	370	225	66,24	8/10
600 Ø	25,5	536	100	376	235	75,9	7/10

-20 cm without flounce

\*The measures of the height are determined by Floor Mounting Plate



## Fixations Packaging



### Wheeled Base With Marbles

85x85x42 - 266 kg

#### Packing

Disassembled Base	85x85x12	10 kg
Marble x8	40x40x8 per pcs	32 kg per pcs /x 8
Marble Packing	Loaded separately from the wheeled base With Pallets	



### Wheeled Base With Marbles - Mini

75x75x42 - 208 kg

#### Packing

Disassembled Base	75x75x12	8 kg
Marble x8	34x34x8 per pcs	25 kg per pcs /x 8
Marble Packing	Loaded separately from the wheeled base With Pallets	

\* For 300x300 and 350x350



### Iroko Wooden Cover

Cover Packing	87x87x17	10 kg
Cover Packing (for mini base)	77x77x17	8 kg

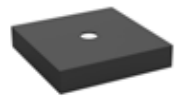

### Compact Cover

Cover Packing	87x87x17	10 kg
Cover Packing (for mini base)	77x77x17	8 kg

## Product Packaging

Nominal size	Packing		Net weight	Gross Weight
cm	cm	m <sup>3</sup>	kg	kg
300x300	401x40x40	0,64	31,5	39,5
350x350	410x40x40	0,656	34	42,5
400x400	431x40x40	0,689	46	55
450x450	438x40x40	0,70	50,5	60,5
500x500	535x40x40	0,856	64	75
550x550	545x40x40	0,87	72	84
600x600	551x40x40	0,88	82,5	95,5

300x400	399x40x40	0,638	41,75	50,75
350x450	431x40x40	0,689	45,50	55,5
400x500	527x40x40	0,84	55	66
450x550	529x40x40	0,846	61,25	73,25
500x600	530x40x40	0,848	73,25	86,25

300 Ø	401x40x40	0,640	28,98	36,98
350 Ø	410x40x40	0,650	31,28	39,78
400 Ø	431x40x40	0,689	42,32	51,32
450 Ø	438x40x40	0,70	46,46	56,46
500 Ø	535x40x40	0,856	58,88	69,88
550 Ø	545x40x40	0,87	66,24	78,24
600 Ø	551x40x40	0,88	75,9	88,9

## CANOPY

- Composition: %100 Solution Dyed Acrylic
- Weight gr/m<sup>2</sup>: 295 Gr/m<sup>2</sup>
- Water replelant: Available
- Fire Resistant: Source 0 (cigarette)
- Color fastness light: ISO 105-B04: 7/8
- Uv protecon: Available

## FABRIC OPTIONS



A-01

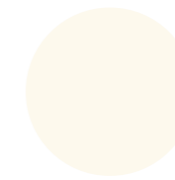

A-02

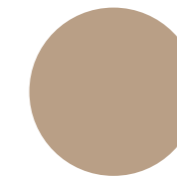

A-03

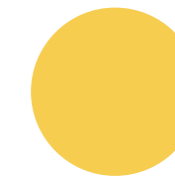

A-04

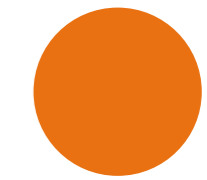

A-05



A-06

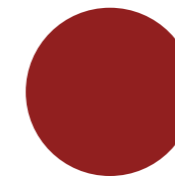

A-07

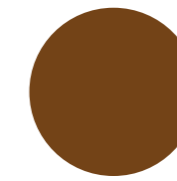

A-08

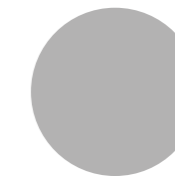

A-09

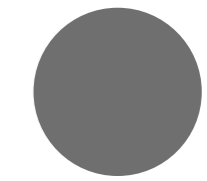

A-10

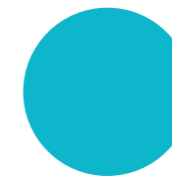

A-11

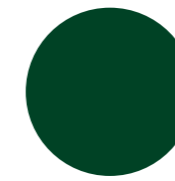

A-12

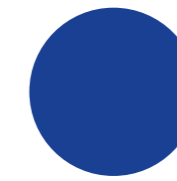

A-13

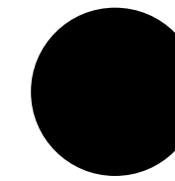

A-14

\* Ask for special production fabric colors and personalization options.

\* Actual fabric and product colours might vary due to technical and printing reasons.



## COSMOS

### PRODUCT

Thanks to the pergolas system that works on vertical working principle between two poles, the Cosmos Parasol was designed in order to create a comfortable shade without any loss of space. The mechanism can easily be operated via the crank arm or the electric motor. The arms carrying the shading fabrics provides protection according to the position of the sun by taking a 30-degree angle back and forward.

For increased comfort under light rain, it is made of high-quality water repellent and fade resistant acrylic fabrics. The shader offers protection against UV rays. Thanks to the durable frame, it gives a longer lifespan against wind and other outdoor weather conditions.

## TECHNOLOGY

The Cosmos Parasol stores energy in its integrated battery by converting sunlight into energy via its solar panels. The remote control commands both the electric motor of the telescopic mechanism and the LED lighting.

The energy components are produced in Türkiye and for lighting Osram 3000 Kelvin LEDs were used.





### **For Homes and Gardens**

For your gardens and terraces, it offers maximum shade area on single pole as well as a relaxing living space under. On sunny days, it provides you with an ideal space to enjoy the outdoors.

### **For Hotels, Restaurants and Outdoor Users**

At your outdoor spaces, you can welcome your guests with a shade comfort that will help them feel special. Moreover, it can easily fit into your design projects for such spaces.

### **Suitable for Architects and Projects**

It is a functional product with various customization possibilities for designers who create stunning outdoor projects.

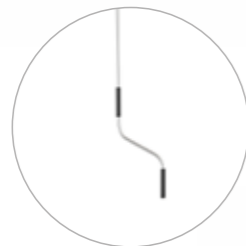

Integrated pulley mechanism



## TECH PACKAGES

- Solar Panel + Led Lights
- Solar Panel + Remote Control Motor + Led Lights + Wind Sensor
- External Power + Led Lights

## FRAME

**Aluminum:** EN-AW/6005 NORM - 85/90 HB HARDENED

**Mast Profile:** 84x84 mm and 3,5 mm wall thickness

**Carrier Rail:** 46x70 mm and 3 mm wall thickness

**Fabric Carrier Arm:** 30x50 mm and 1,5 mm wall thickness

## Frame Coloring

Natural anodised aluminum color

**Optional:** Powder-Coated Ral color selections

## HOW TO OPERATE

- Through the detachable crank arm, the rolling mechanism moves easily.
- With the press of a button, the optional electric arm assists the motion of the motor via the remote control connection.



Rail system



Solar panel

## FIXATIONS



Wooden Mounting Plate Set



High Resistance For Wind  
Floor Mounting Plate  
(Requires professional installation)

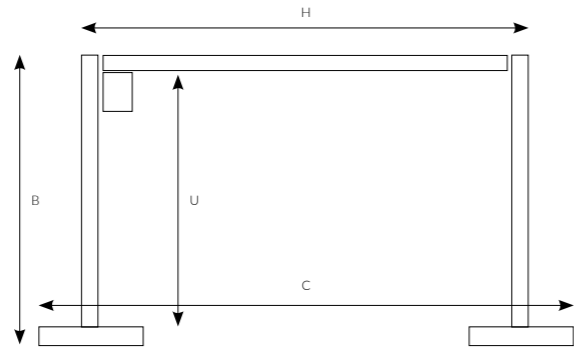

### Product Sizes

Nominal size	Covered area	Height	Headroom	Pole to pole width	Total width	Wind Resistance
cm	m <sup>2</sup>	cm	cm	cm	cm	1/10
		B	U	H	C	
250x300	7,5	232	220	330	400	10/10
250x360	9	232	220	390	460	9/10
250x420	10,5	232	220	450	530	9/10
250x480	12	232	220	510	590	8/10
300x300	9	232	220	330	400	10/10
300x360	10,8	232	220	390	470	9/10
300x420	12,6	232	220	450	530	9/10
300x480	14,4	232	220	510	610	8/10
350x300	10,5	242	230	330	410	10/10
350x360	12,6	242	230	390	480	9/10
350x420	14,7	242	230	450	540	9/10
350x480	16,8	242	230	510	610	8/10
400x300	12	242	230	330	420	10/10
400x360	14,4	242	230	390	490	9/10
400x420	16,8	242	230	450	550	9/10
400x480	19,2	242	230	510	610	8/10

### Product Packaging

Packing	Net Weight	Gross Weight
cm	m <sup>3</sup>	kg
330x40x40	0,528	72,25
390x40x40	0,624	74,7
450x40x40	0,72	77,15
510x40x40	0,816	79,6
330x40x40	0,528	76,7
390x40x40	0,624	79,75
450x40x40	0,72	82,8
510x40x40	0,816	85,8
330x40x40	0,528	81,15
390x40x40	0,624	84,8
450x40x40	0,72	88,4
510x40x40	0,816	92,1
330x40x40	0,528	85,6
390x40x40	0,624	89,8
450x40x40	0,72	94,1
510x40x40	0,816	98,3

\*The measures of the height are determined by Wooden Mounting Plate Set

### Fixations Packaging



**Wooden Mounting Plate Set**

Palette	100x120x75	
Weight Selections	350 kg	450 kg
	550 kg	650 kg

Weight selections depends on conditions

### CANOPY

- Composition: %100 Solution Dyed Acrylic
- Weight gr/m<sup>2</sup>: 295 Gr/m<sup>2</sup>
- Water replelant: Available
- Fire Resistant: Source 0 (cigarette)
- Color fastness light: ISO 105-B04: 7/8
- Uv protecon: Available

### FABRIC OPTIONS

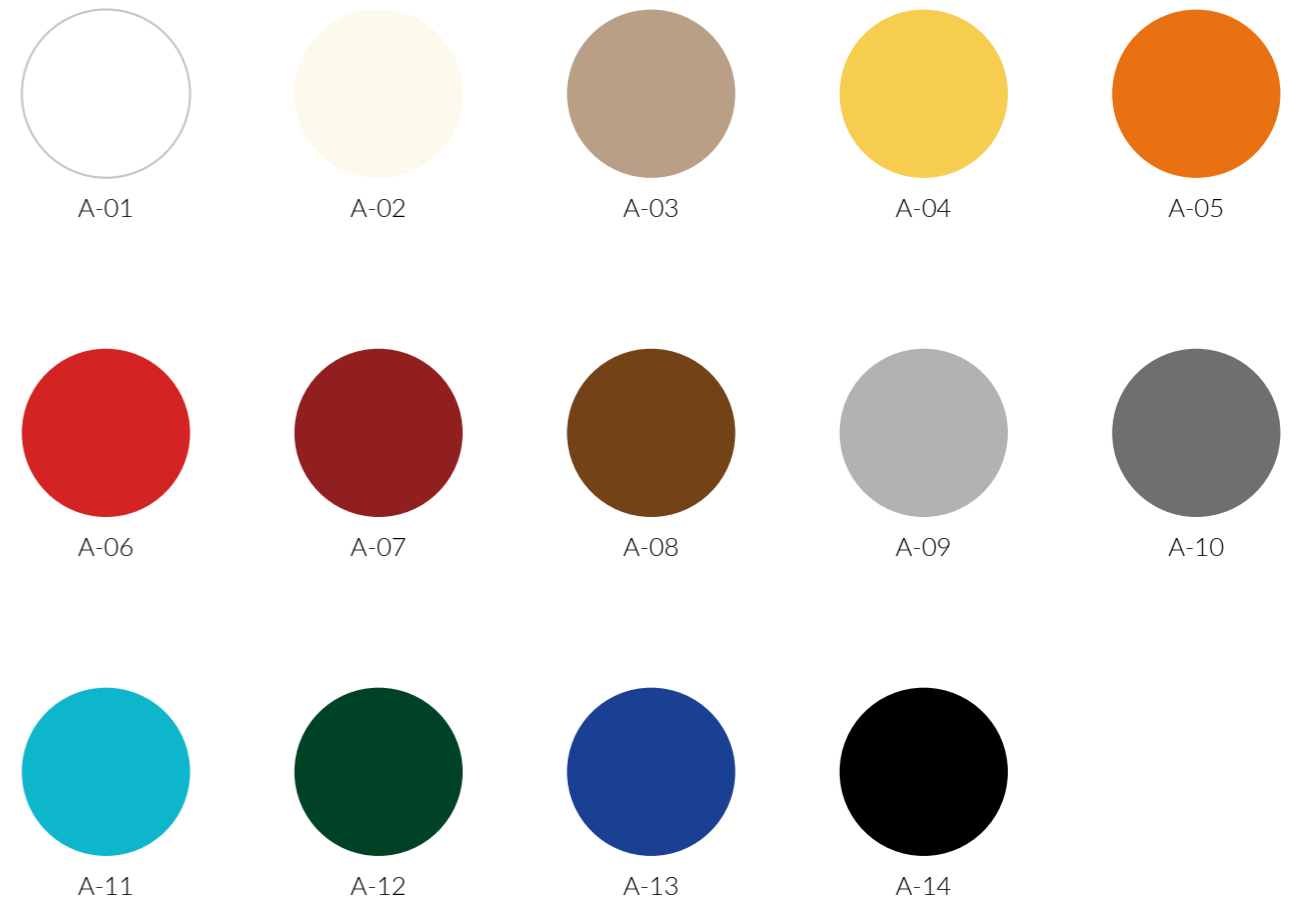

- \* Ask for special production fabric colors and personalization options.
- \* Actual fabric and product colours might vary due to technical and printing reasons.



## ALBATROS

### PRODUCT

The Albatros Parasol was inspired by the wide wings of the Albatross birds. It adds independence and comfort to your spaces without any space loss by providing the maximum shade under the parasol through its durable cantilever frame.

Thanks to the unilateral System X mechanism, it offers an easy and a long-lasting use. The Albatros parasol, powered by a suspension to operate the large mechanism, presents users an easy opening with minimum effort. Thanks to the 360 degrees rotating base, you can create shade on different areas without changing the position of the parasol.

For increased comfort under light rain, it is made of high-quality water repellent and fade resistant acrylic fabrics. It offers protection against UV rays via the shade on the parasol. It proffers a long-lasting use due to its frame durable against winds and strong weather conditions.





### **For Hotels and Restaurants**

They offer maximum protection for outdoor living areas of hotels and restaurants. The durable and long-lasting structure help you and your guests have joyful moments under both sunny hot days and light rain conditions.

### **For Brands and Shops**

It furnishes your guests with a unified comfort area via your corporate identity thanks to its logo customization features for organizations like restaurants and hotels, frame and fabric customization features, complementary accessories.

### **For Gardens and Outdoor Areas**

On single pole, it offers maximum shading and a comfortable living area at your gardens and terraces. It provides you with an ideal comfort area so that you can enjoy nice weather outside.

### **Suitable for Profesional Users**

It helps professional users and designers developing projects add comfort and joy to the locations they work on.



Shock absorber support



Durable aluminum body and arms

## LIFT SYSTEM

It possesses a unilateral X System feature. The hydraulic support helps slide system raise. Following the movement, the system locks the position.

## FRAME

Aluminum: EN 755-9 NORM

Mast Profile: 68x95 mm and 3 mm wall thickness

Carrier Arm: 52x60 mm and 2,5 mm wall thickness

Fabric Carrier Arm: 20x32 mm and 2 mm wall thickness

## Frame Coloring

Natural anodised aluminum color

Optional: Powder-Coated Ral color selections

## FIXATIONS



Weight: 250 -130 kg

Albatros 360 wheely marble base

## ADDITIONAL OPTIONS



- Decorative Compact Cover for wheeled stand



- Logo printing (flounce and roof)



- Flounce



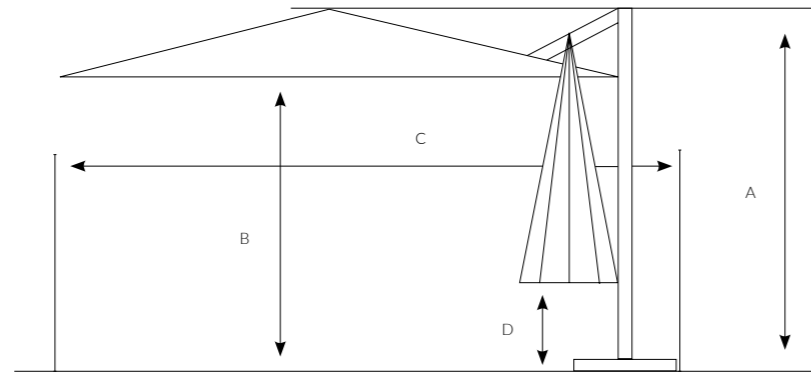

## CANOPY

- Composition: %100 Solution Dyed Acrylic
- Weight gr/m<sup>2</sup>: 295 Gr/m<sup>2</sup>
- Water repellent: Available
- Fire Resistant: Source 0 (cigarette)
- Color fastness light: ISO 105-B04: 7/8
- Uv protection: Available

## FABRIC OPTIONS

### Product Sizes

Nominal size	Covered area	Height	Headroom	Total width	Closed Canopy height	Wind Resistance
cm	m <sup>2</sup>	cm	cm	cm	cm	1/10
		A	B	C	D	
400x400	16	328	217	429	50	6/10
350x350	12,25	311	217	405	50	8/10
300x300	9	295	215	374	70	9/10

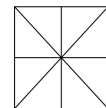

### Product Packaging

Packing		Weight
cm	m <sup>3</sup>	kg
33x55x420	0,45	60
33x55x400	0,41	55
33x55x370	0,67	50

### Fixations Packaging



**360 Wheely  
Marble Base**

Packing		
Disassembled Base	85x85x45	15 kg
Marble	40x40x8 per pcs	32 kg per pcs
Weight Selections	250 kg - 8x marble	130 kg - 4x marble
Marble Packing	Loaded separately from the wheeled base With Pallets	



A-01



A-02

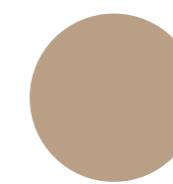

A-03



A-04



A-05

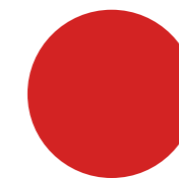

A-06

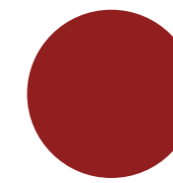

A-07

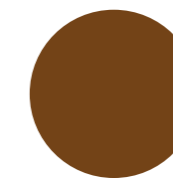

A-08

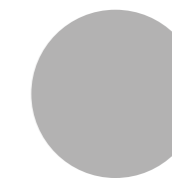

A-09

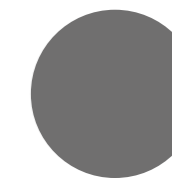

A-10

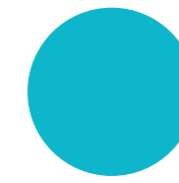

A-11

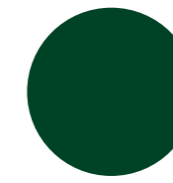

A-12

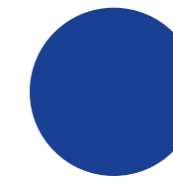

A-13

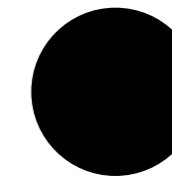

A-14

\* Ask for special production fabric colors and personalization options.

\* Actual fabric and product colours might vary due to technical and printing reasons.

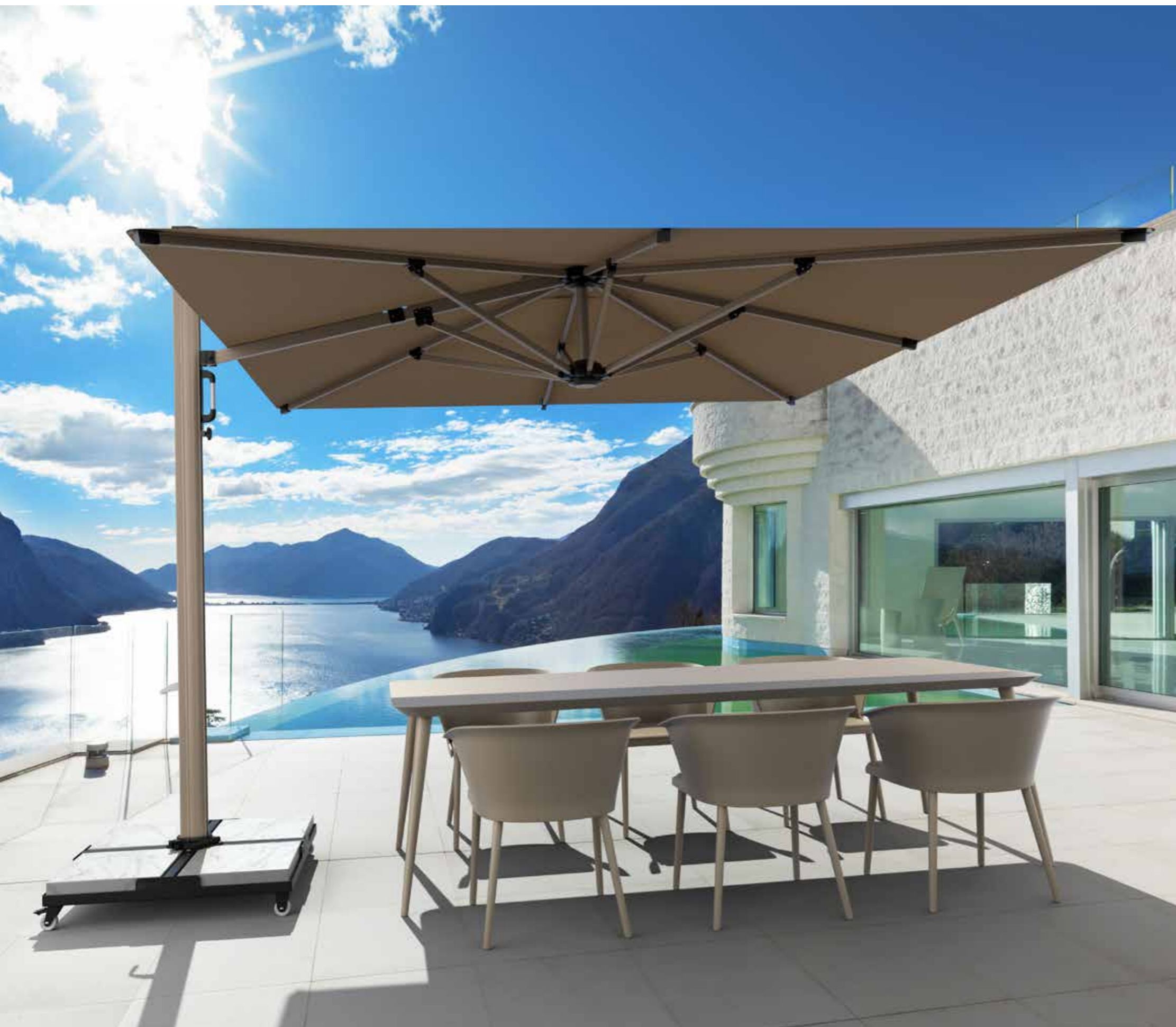

## RODOS

### PRODUCT

Thanks to its cantilever design, the Rodos Parasol was produced to protect you from the sun and to add more comfort to your life without sacrificing shading space, especially around outdoor seating sets.

The Rodos Parasol, which can be opened by cranking the fixed arm, can easily be tilted so that you can protect yourself at different times during the day. The 360-degree rotating base, it can also shift shading area to neighbouring areas seamlessly.

For increased comfort under light rain, it is made of high-quality water repellent and fade resistant polypropylene fabrics. It offers protection against UV rays via the shade on the parasol. It offers a long-lasting use due to its frame durable against winds and strong weather conditions.



### For Homes and Gardens

For your gardens and terraces, it offers maximum shade area on single pole as well as a relaxing living space under. On sunny days, it provides you with an ideal space to enjoy the outdoors.

### For Hotels, Restaurants and Outdoor Users

At your outdoor spaces, you can welcome your guests with a shade comfort that will help them feel special. Moreover, it can easily fit into your design projects for such spaces.

### Suitable for Architects and Projects

It is a functional product with various customization possibilities for designers who create stunning outdoor projects.



### How To Operate

You can open and close Rodos using the removable hand crank. When its fully open it can have tilt by loosening the locking lever.

Press the pedal that located on marble base to rotate 360°.

## FRAME

**Mast Profile:** 60x90 mm and 2 mm wall thickness

**Carrier Arm:** 30x52 mm and 2 mm wall thickness

**Fabric Carrier Arm:** 20x30 mm and 1,5 mm wall thickness



## Frame Coloring

**DARK GREY:** RAL 7016

**TAUPE:** RAL 1019

## FIXATIONS



Weight: 127 kg

360 wheely marble base

## ADDITIONAL OPTIONS



- Decorative Ireko Wooden Cover for wheeled stand



- Decorative Compact Cover for wheeled stand



- Logo printing (flounce and roof)



- Flounce

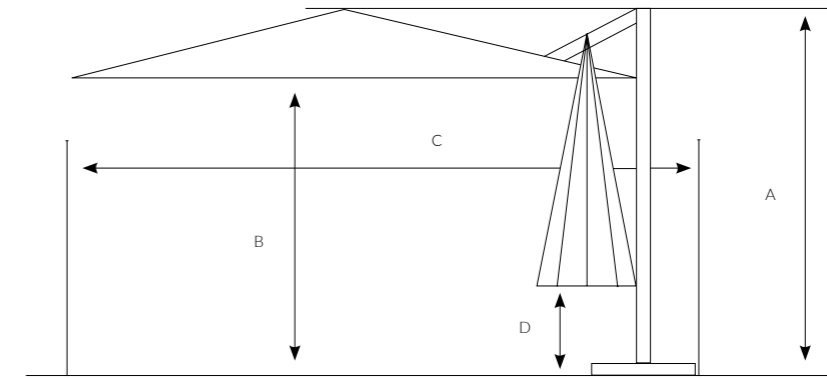

## Product Sizes

Nominal size	Covered area	Height	Headroom	Total width	Closed Canopy height	Wind Resistance
cm	m <sup>2</sup>	cm	cm	cm	cm	1/10
300x300	9	275	210	360	60	8/10

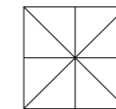

## Product Packaging

Packing		Weight
cm	m <sup>3</sup>	kg
24x51x265	0,32	35

## Fixations Packaging



**360 Wheely Marble Base**  
90x90x25 - 128 kg

Packing	
Disassembled Base	90x90x25 with single parcel packing
Marble x4	40x40x8 per pcs   32 kg per pcs/x 4
Marble Packing	Loaded separately from the wheeled base With Pallets

## CANOPY

- Composition: %100 Yarn Dyed Polypropylene
- Weight gr/m<sup>2</sup>: 230 Gr/m<sup>2</sup>
- Water repellent: Available
- Fire Resistant: Source 0 (cigarette)
- Color fastness light: ISO 105-B04: 7/8
- Martindale: 25,000 Rubs
- Uv protecon: Available

## FABRIC OPTIONS



PP-01

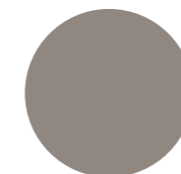

PP-02

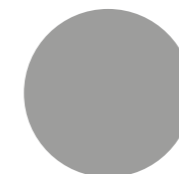

PP-03

\* Ask for special production fabric colors and personalization options.

\* Actual fabric and product colours might vary due to technical and printing reasons.



## TROPIC

### PRODUCT

With a plain and functional design, The Tropic Parasol was produced to create shades for sunbeds and small size seating sets.

The locking system made of aluminium not only gives strength but also an aesthetic view.

For increased comfort under light rain, it is made of high-quality water repellent and fade resistant polypropylene fabrics. It offers projection against UV rays via the shader on the parasol. It proffers a long-lasting use due to its frame durable against winds and strong weather conditions.



### For Hotels and Restaurants

They offer maximum protection for outdoor living areas of hotels and restaurants. The durable and long-lasting structure help you and your guests have joyful moments under both sunny hot days and light rain conditions.

### For Brands and Shops

It furnishes your guests with a unified comfort area via your corporate identity thanks to its logo customization features for organizations like restaurants and hotels, frame and fabric customization features, complementary accessories.

### For Gardens and Outdoor Areas

For Gardens and Outdoor Areas  
On single pole, it offers maximum shading and a comfortable living area at your gardens and terraces. It provides you with an ideal comfort area so that you can enjoy nice weather outside.

### For Poolsides and Sunlounger Sets

By the pools or on the beaches, it helps you create a shading space for two sunbeds.



### How To Operate

The parasol opens properly first by pushing the sliding mechanism up and then by locking into position on the lock mechanism.

### FIXATIONS



*Wheeled Marble Base*



*70 LT. Water Tank*



*70 KG. Cement Filled Base*



*Fixed Demountable Plastic Base Set*

### ADDITIONAL OPTIONS



- Decorative Ireko Wooden Cover for wheeled stand



- Decorative Compact Cover for wheeled stand



- Logo printing (flounce and roof)



- Flounce



## FRAME

Mast Profile: Ø50 mm and 2 mm wall thickness - Aluminum

Fabric Carrier Arm: 20x30 mm and 1,5 mm wall thickness - Aluminum

## Frame Coloring

DARK GREY: RAL 7016

TAUPE: RAL 1019

WHITE: RAL 9003

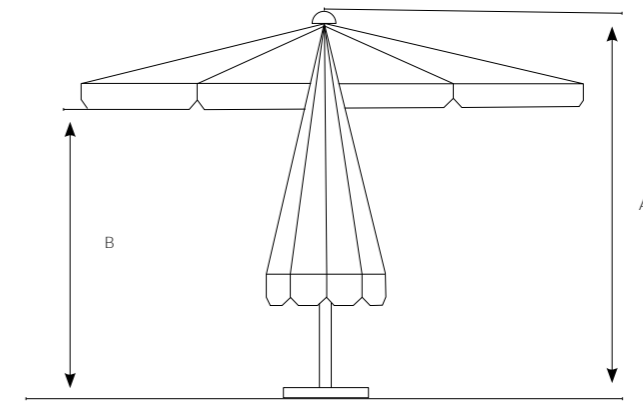

## Fixations Packaging



**Wheeled Marble Base**  
60x60x42 - 83 kg

Disassembled Base	60x60x12	10 kg
Marble x4	27x27x10 per pcs	18,25 kg per pcs
Marble Packing	Loaded separately from the wheeled base With Pallets	
Color Selections	White	Black



**Water Tank**  
62x62x24 - 70 lt

Empty Base	62x62x24	3,7 kg - 70 lt.
Full Weight	Water - 70 kg	18,25 kg per pcs
Package	62x62x110 cm	4 unit per package
Color Selections	White	Dark Grey



**Cement Filled Base**  
62x62x15 - 75 kg

Base	62x62x15	75 kg
Color Selections	White	Black



**Fixed Demountable Plastic Base Set**  
81x81x33 - 80 lt

Disassembled Base	81x81x11	12 kg
Water Tank x4	40x40x60	20 lt. per pcs
Color Selections	Black	

## Product Sizes

Nominal size	Covered area	Height	Headroom	Wind Resistance
cm	m <sup>2</sup>	cm	cm	1/10
		A	B	
260x260	6,76	255	180	9/10

## Product Packaging

Packing		Weight
cm	m <sup>3</sup>	kg
23x23x260	0,138	12,5

## CANOPY

- Composition: %100 Yarn Dyed Polypropylene
- Weight gr/m<sup>2</sup>: 230 Gr/m<sup>2</sup>
- Water repellent: Available
- Fire Resistant: Source 0 (cigarette)
- Color fastness light: ISO 105-B04: 7/8
- Martindale: 25,000 Rubs
- Uv protection: Available

## FABRIC OPTIONS

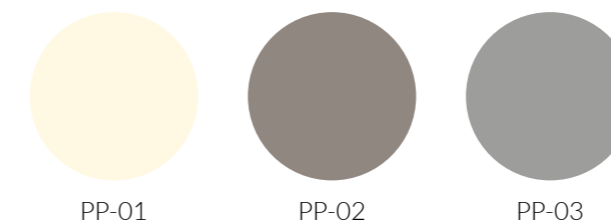

\* Ask for special production fabric colors and personalization options.

\* Actual fabric and product colours might vary due to technical and printing reasons.



## PULLEY

### PRODUCT

The long-lasting Pulley series have a pulley mechanism, and they were designed to create practical and comfortable shading for your spaces.

You can easily open your parasol after the integrated pulley is pulled and tied onto the hook on the frame.

For uninterrupted comfort under light rain, it is made of high-quality water repellent and fade resistant polyester fabrics. It offers a long-lasting use due to its frame durable against winds and strong weather conditions.

### **For Hotels and Restaurants**

They offer maximum protection for outdoor living areas of hotels and restaurants. The durable and long-lasting structure help you and your guests have joyful moments under both sunny hot days and light rain conditions.

### **For Brands and Shops**

It furnishes your guests with a unified comfort area via your corporate identity thanks to its logo customization features for organizations like restaurants and hotels, frame and fabric customization features, complementary accessories.

### **For Gardens and Outdoor Areas**

On single pole, it offers maximum shading and a comfortable living area at your gardens and terraces. It provides you with an ideal comfort area so that you can enjoy nice weather outside.





Durable aluminum frame



Air vents

## FRAME

**Mast Profile:** Ø50 mm and 2 mm wall thickness - Aluminum

**Fabric Carrier Arm:** 19x29 mm and 1,5 mm wall thickness - Aluminum

## Frame Coloring

**WHITE:** RAL 9003

## HOW TO OPERATE

The parasol can seamlessly be opened by pulling the integrated pulley and tying it onto the hook on the frame.



## FIXATIONS



*Wheeled Marble Base*



*70 LT. Water Tank*



*70 KG. Cement Filled Base*



*Fixed Demountable Plastic Base Set*

## ADDITIONAL OPTIONS



- Decorative Compact Cover for wheeled stand



- Logo printing (flounce and roof)



- Flounce



**PULLEY 300Q**



**PULLEY 400Q**



**PULLEY 3x3**



**PULLEY PLUS+ 330x330**

## CANOPY

Polyester - 180 gr/m<sup>2</sup>

## FABRIC OPTIONS



PY-01

\* Ask for special production fabric colors.

\* Actual fabric and product colours might vary due to technical and printing reasons.

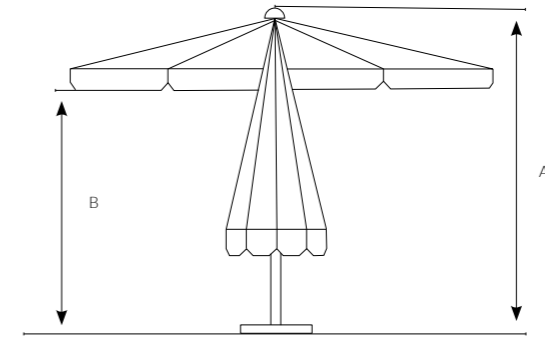

## Product Sizes

Nominal size	Covered area	Height	Headroom	Wind Resistance
cm	m <sup>2</sup>	cm	cm	1/10
		A	B	
300Q	6,4	255	180	8/10
300x300	9	275	200	7/10
330x330 Plus	10,89	295	220	7/10
400Q	11,30	275	200	6/10

## Product Packaging

Packing		Weight
cm	m <sup>3</sup>	kg
23x23x260	0,138	12,5
23x23x283	0,169	14,75
23x23x300	0,16	15,3
23x23x283	0,15	19

## Fixations Packaging



**Wheeled Marble Base**  
60x60x42 - 83 kg

Disassembled Base	60x60x12	10 kg
Marble x4	27x27x10 per pcs	18,25 kg per pcs
Marble Packing	Loaded separately from the wheeled base With Pallets	
Color Selections	White	Black



**Water Tank**  
62x62x24 - 70 lt

Empty Base	62x62x24	3,7 kg - 70 lt.
Full Weight	Water - 70 kg	18,25 kg per pcs
Package	62x62x110 cm	4 unit per package
Color Selections	White	Dark Grey



**Cement Filled Base**  
62x62x15 - 75 kg

Base	62x62x15	75 kg
Color Selections	White	Black

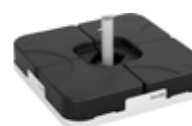

**Fixed Demountable Plastic Base Set**  
81x81x33 - 80 lt

Disassembled Base	81x81x11	12 kg
Water Tank x4	40x40x60	20 lt. per pcs
Color Selections	Black	

## INFORMATION

Technical dates and pictures in this catalogue are indicative and may not be considered binding; Tevalli Parasol's reserves the right to modify without notice for technical or commercial reasons the products in this catalogue. It is forbidden to re-produce the project or to re-print the catalogue.

*All dimensions are in **cm**.*

### SYMBOLS KEY

Ø = Diameter

H = Height

*Art Direction & Graphic Art*  
[www.adkreatik.com](http://www.adkreatik.com)

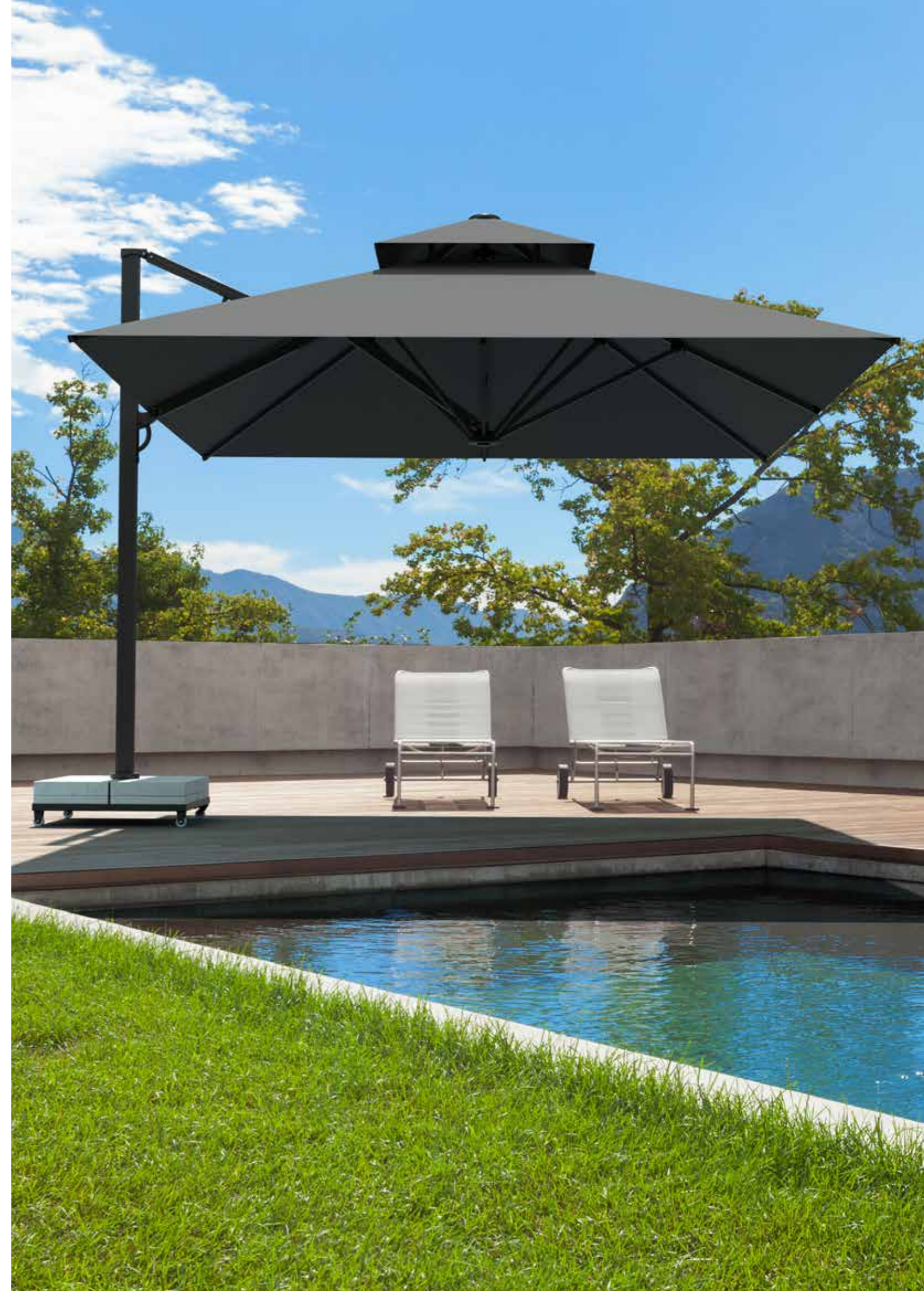

*tevalli*<sup>®</sup>  
*parasol's*

[www.tevalliparasols.com.tr](http://www.tevalliparasols.com.tr)



/ tevalliparasols

by **TÜRKLER**<sup>®</sup>